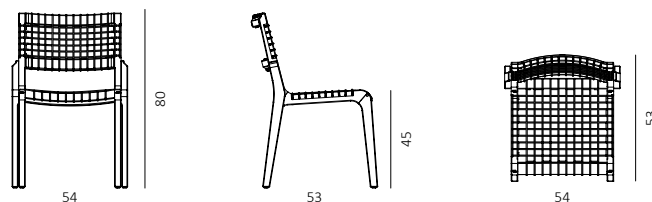

codice prodotto: **SESY**

Sedia dalla struttura squadrata in teak con seduta e schienale in waprolace color naturale.

Prodotto impilabile.

CONDIZIONI DI UTILIZZO

- H** Hard Conditions: locali ad alta frequentazione (bar, pub)
- SG** Seaside
- M** Medium Conditions: utilizzo HORECA

MATERIALI E FINITURE

Telaio in teak



Teak

Intreccio WaProLace



Natural

TIPOLOGIA DI PRODOTTO

Assemblato

CERTIFICAZIONI

EN 1022/05
EN 581-1/06
ENV 581-1/00 e 581-2/00

certificazione IMO

IMBALLO

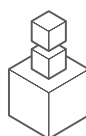

2 pz



15,2 Kg

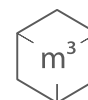

0,334 m³

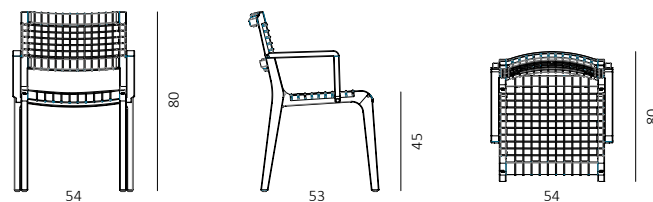

58 x 64 x 90 cm

codice prodotto: **POSY**

Poltroncina dalla struttura squadrata in teak con seduta e schienale in waprolace color naturale.

CONDIZIONI DI UTILIZZO

- H** Hard Conditions: locali ad alta frequentazione (bar, pub)
- SG** Seaside
- M** Medium Conditions: utilizzo HORECA

MATERIALI E FINITURE

Telaio in teak



Teak

Intreccio WaProLace



Natural

TIPOLOGIA DI PRODOTTO

Assemblato

CERTIFICAZIONI

EN 1022/05
EN 581-1/06
ENV 581-1/00 e 581-2/00

certificazione IMO

IMBALLO

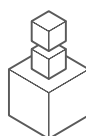

2 pz

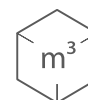

17,8 Kg

0,509 m³

117 x 64,5 x 67,5cm

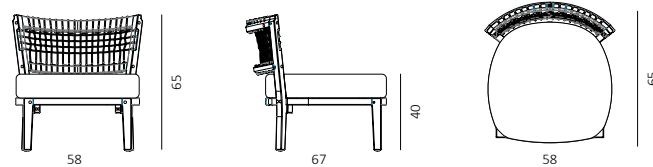
codice prodotto: **SYPB**

Poltroncina bassa dalla struttura squadrata in teak con seduta e schienale in waprolace color naturale.

CONDIZIONI DI UTILIZZO

- H** Hard Conditions: locali ad alta frequentazione (bar, pub)
- SG** Seaside
- M** Medium Conditions: utilizzo HORECA

MATERIALI E FINITURE

Telaio in teak



Teak

Intreccio WaProLace



Natural

TIPOLOGIA DI PRODOTTO

Assemblato

CERTIFICAZIONI

EN 1022/05
EN 581-1/06
ENV 581-1/00 e 581-2/00

certificazione IMO

IMBALLO

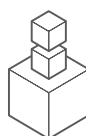

2 pz

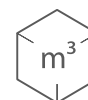

17 Kg

0,466 m³

66 x 76 x 93 cm

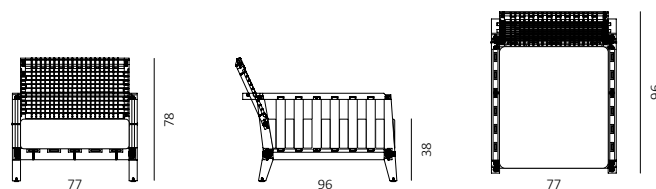
codice prodotto: **SYPO**

Poltrona dalla struttura squadrata in teak con seduta e schienale in waprolace color naturale.

CONDIZIONI DI UTILIZZO

- H** Hard Conditions: locali ad alta frequentazione (bar, pub)
- SG** Seaside
- M** Medium Conditions: utilizzo HORECA

MATERIALI E FINITURE

Telaio in teak



Teak

Intreccio WaProLace



Natural

TIPOLOGIA DI PRODOTTO

Da assemblare

CERTIFICAZIONI

EN 1022/05
EN 581-1/06
ENV 581-1/00 e 581-2/00

certificazione IMO

IMBALLO

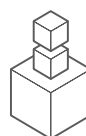

1 pz

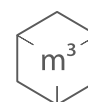

22,2 Kg

0,147 m³

78 x 99 x 19 cm

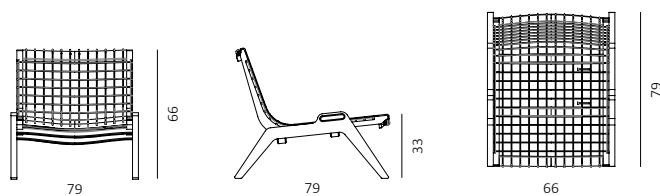
codice prodotto: **POLOS**

Poltrona lounge dalla struttura squadrata in teak con seduta e schienale in waprolace color naturale.

Prodotto impilabile.

CONDIZIONI DI UTILIZZO

- H** Hard Conditions: locali ad alta frequentazione (bar, pub)
- SG** Seaside
- M** Medium Conditions: utilizzo HORECA

MATERIALI E FINITURE

Telaio in teak



Teak

Intreccio WaProLace



Natural

TIPOLOGIA DI PRODOTTO

Da assemblare

CERTIFICAZIONI

EN 1022/05
EN 581-1/06
ENV 581-1/00 e 581-2/00

certificazione IMO

IMBALLO

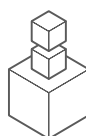

1 pz



20 Kg

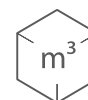

0,387 m³



75 x 86 x 60 cm

codice prodotto: **SYPU**

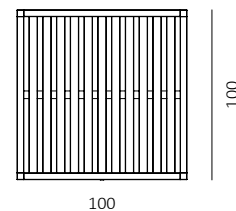
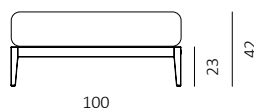

Pouf dalla struttura squadrata in teak.

CONDIZIONI DI UTILIZZO



Hard Conditions: locali ad alta frequentazione (bar, pub)



Seaside



Medium Conditions: utilizzo HORECA

MATERIALI E FINITURE

Telaio in teak



Teak

TIPOLOGIA DI PRODOTTO

Assemblato

CERTIFICAZIONI

EN 1022/05
EN 581-1/06
ENV 581-1/00 e 581-2/00

certificazione IMO

IMBALLO

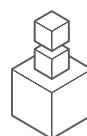

1 pz



20 Kg

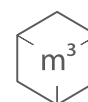

0,337 m³

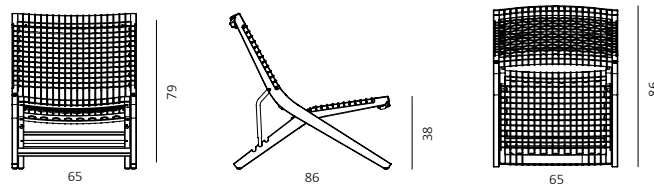

106 x 30 x 106 cm

codice prodotto: **SDRASY**

Sdraio pieghevole dalla struttura squadrata in teak con seduta e schienale in waprolace color naturale.

Prodotto pieghevole.

CONDIZIONI DI UTILIZZO

- H** Hard Conditions: locali ad alta frequentazione (bar, pub)
- SG** Seaside
- M** Medium Conditions: utilizzo HORECA

MATERIALI E FINITURE

Telaio in teak



Teak

Intreccio WaProLace



Natural

TIPOLOGIA DI PRODOTTO

Assemblato

CERTIFICAZIONI

EN 1022/05
EN 581-1/06
ENV 581-1/00 e 581-2/00

certificazione IMO

IMBALLO

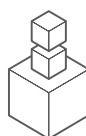

1 pz

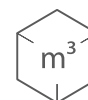

11,4 Kg

0.165 m³

70 x 118 x 20 cm

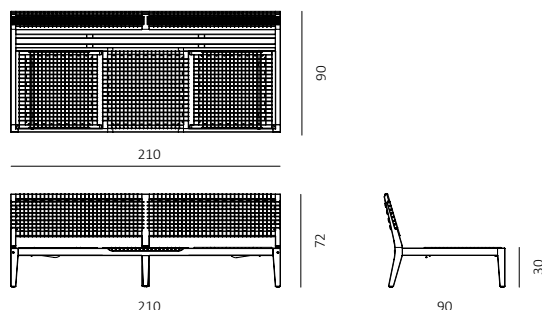
codice prodotto: **SYLD**

Divano-lettino con seduta regolabile su entrambi i lati dalla struttura squadrata in teak con seduta e schienale in waprolace color naturale.

CONDIZIONI DI UTILIZZO

- H** Hard Conditions: locali ad alta frequentazione (bar, pub)
- SG** Seaside
- M** Medium Conditions: utilizzo HORECA

MATERIALI E FINITURE

Telaio in teak

Intreccio WaProLace



Teak



Natural

TIPOLOGIA DI PRODOTTO

Da assemblare

CERTIFICAZIONI

EN 1022/05
EN 581-1/06
ENV 581-1/00 e 581-2/00

certificazione IMO

IMBALLO

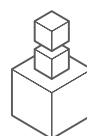

1 pz

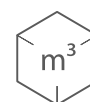

39 Kg

0,436 m³

22 x 220 x 90 cm

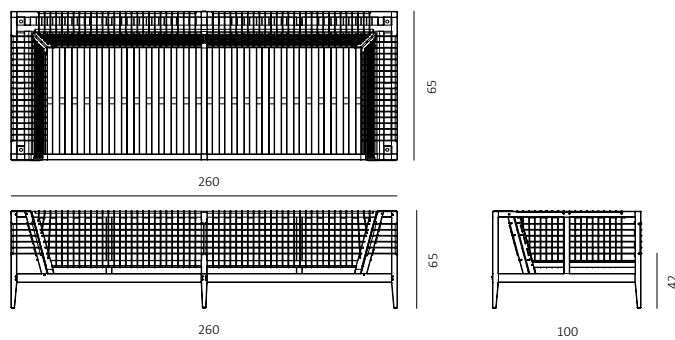
codice prodotto: **SYDIG**

Divano dalla struttura squadrata in teak con seduta e schienale in wapolace color naturale.

CONDIZIONI DI UTILIZZO

- H** Hard Conditions: locali ad alta frequentazione (bar, pub)
- SG** Seaside
- M** Medium Conditions: utilizzo HORECA

MATERIALI E FINITURE

Telaio in teak

Intreccio WaProLace



Teak



Natural

TIPOLOGIA DI PRODOTTO

Assemblato

CERTIFICAZIONI

EN 1022/05
EN 581-1/06
ENV 581-1/00 e 581-2/00

certificazione IMO

IMBALLO

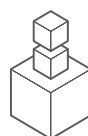

1 pz

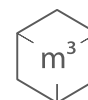

90 Kg

2,814 m³

115 x 275 x 89 cm

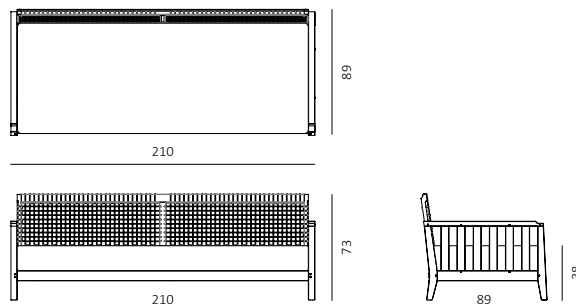
codice prodotto: **SYDI**

Divano dalla struttura squadrata in teak con seduta e schienale in waprolace color naturale.

CONDIZIONI DI UTILIZZO

- H** Hard Conditions: locali ad alta frequentazione (bar, pub)
- SG** Seaside
- M** Medium Conditions: utilizzo HORECA

MATERIALI E FINITURE

Telaio in teak



Teak

Intreccio WaProLace



Natural

TIPOLOGIA DI PRODOTTO

Da assemblare

CERTIFICAZIONI

EN 1022/05
EN 581-1/06
ENV 581-1/00 e 581-2/00

certificazione IMO

IMBALLO

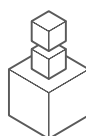

1 pz

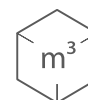

37,4 Kg

0,271 m³

210 x 86 x 15 cm

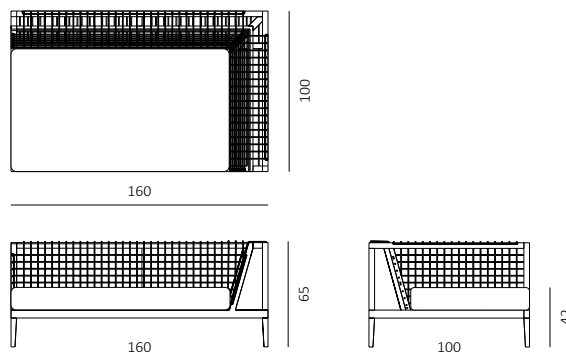
codice prodotto: **SYANS**

Modulo angolo sinistro dalla struttura squadrata in teak con seduta e schienale in waprolace color naturale.

CONDIZIONI DI UTILIZZO

- H** Hard Conditions: locali ad alta frequentazione (bar, pub)
- SG** Seaside
- M** Medium Conditions: utilizzo HORECA

MATERIALI E FINITURE

Telaio in teak

Intreccio WaProLace



Teak



Natural

TIPOLOGIA DI PRODOTTO

Assemblato

CERTIFICAZIONI

EN 1022/05
EN 581-1/06
ENV 581-1/00 e 581-2/00

certificazione IMO

IMBALLO

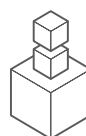

1 pz

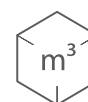

36 Kg

1,179 m³

166 x 67 x 106 cm

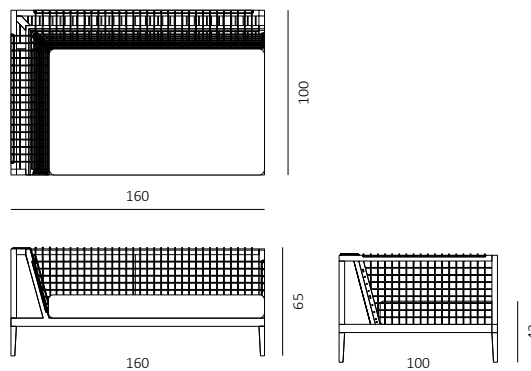
codice prodotto: **SYAND**

Modulo angolo destro dalla struttura squadrata in teak con seduta e schienale in waprolace color naturale.

CONDIZIONI DI UTILIZZO

- H** Hard Conditions: locali ad alta frequentazione (bar, pub)
- SG** Seaside
- M** Medium Conditions: utilizzo HORECA

MATERIALI E FINITURE

Telaio in teak



Teak

Intreccio WaProLace



Natural

TIPOLOGIA DI PRODOTTO

Assemblato

CERTIFICAZIONI

EN 1022/05
EN 581-1/06
ENV 581-1/00 e 581-2/00

certificazione IMO

IMBALLO

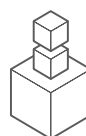

1 pz

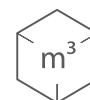

36 Kg

1,179 m³

166 x 67 x 106 cm

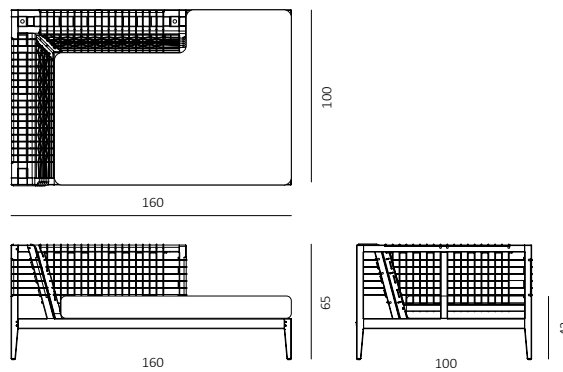
codice prodotto: **SYCHS**

Modulo chaise-longue sinistro dalla struttura squadrata in teak con seduta e schienale in waprolace color naturale.

CONDIZIONI DI UTILIZZO

- H** Hard Conditions: locali ad alta frequentazione (bar, pub)
- SG** Seaside
- M** Medium Conditions: utilizzo HORECA

MATERIALI E FINITURE

Telaio in teak

Intreccio WaProLace



Teak



Natural

TIPOLOGIA DI PRODOTTO

Assemblato

CERTIFICAZIONI

EN 1022/05
EN 581-1/06
ENV 581-1/00 e 581-2/00

certificazione IMO

IMBALLO

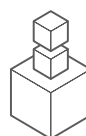

1 pz

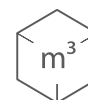

36 Kg

1,179 m³

166 x 67 x 106 cm

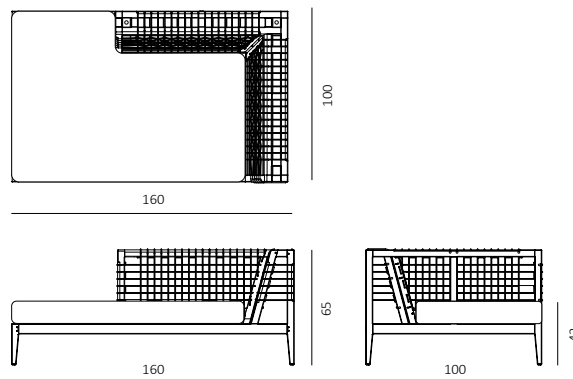
codice prodotto: **SYCHD**

Modulo chaise-longue destro dalla struttura squadrata in teak con seduta e schienale in waprolace color naturale.

CONDIZIONI DI UTILIZZO

- H** Hard Conditions: locali ad alta frequentazione (bar, pub)
- SG** Seaside
- M** Medium Conditions: utilizzo HORECA

MATERIALI E FINITURE

Telaio in teak

Intreccio WaProLace



Teak



Natural

TIPOLOGIA DI PRODOTTO

Assemblato

CERTIFICAZIONI

EN 1022/05
 EN 581-1/06
 ENV 581-1/00 e 581-2/00

certificazione IMO

IMBALLO

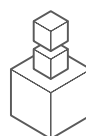

1 pz

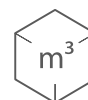

36 Kg

1,179 m³

166 x 67 x 106 cm

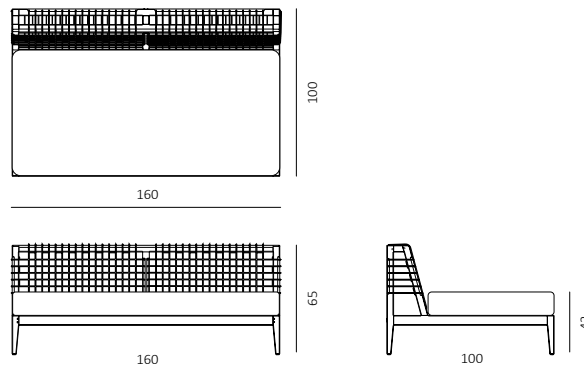
codice prodotto: **SYSP**

Modulo spalla dalla struttura squadrata in teak con seduta e schienale in waprolace color naturale.

CONDIZIONI DI UTILIZZO

- H** Hard Conditions: locali ad alta frequentazione (bar, pub)
- SG** Seaside
- M** Medium Conditions: utilizzo HORECA

MATERIALI E FINITURE

Telaio in teak



Teak

Intreccio WaProLace



Natural

TIPOLOGIA DI PRODOTTO

Assemblato

CERTIFICAZIONI

EN 1022/05
EN 581-1/06
ENV 581-1/00 e 581-2/00

certificazione IMO

IMBALLO

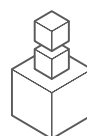

1 pz

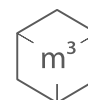

36 Kg

1,179 m³

166 x 67 x 106 cm

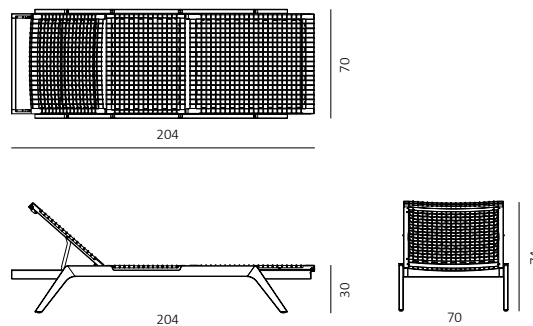
codice prodotto: **LESY**

Letto dalla struttura squadrata in teak con seduta e schienale in waprolace color naturale.

Prodotto impilabile.

CONDIZIONI DI UTILIZZO

- H** Hard Conditions: locali ad alta frequentazione (bar, pub)
- SG** Seaside
- M** Medium Conditions: utilizzo HORECA

MATERIALI E FINITURE

Telaio in teak



Teak

Intreccio WaProLace



Natural

TIPOLOGIA DI PRODOTTO

Da assemblare

CERTIFICAZIONI

EN 1022/05
EN 581-1/06
ENV 581-1/00 e 581-2/00

certificazione IMO

IMBALLO

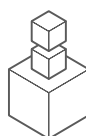

1 pz



22,8 Kg

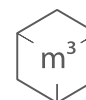

0,221 m³

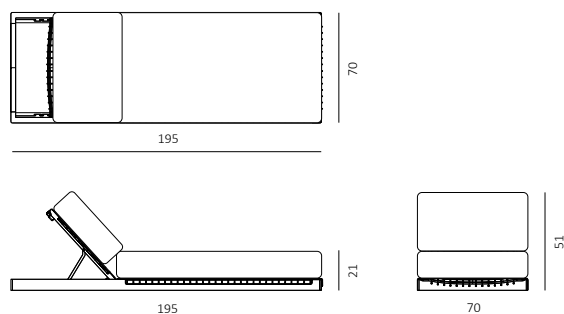

69 x 200 x 16 cm

codice prodotto: **SYLEB**

Letto basso dalla struttura squadrata in teak con seduta e schienale in waprolace color naturale.

CONDIZIONI DI UTILIZZO

H

Hard Conditions: locali ad alta frequentazione (bar, pub)

SG

Seaside

M

Medium Conditions: utilizzo HORECA

MATERIALI E FINITURE

Telaio in teak



Teak

Intreccio WaProLace



Natural

TIPOLOGIA DI PRODOTTO

Assemblato

CERTIFICAZIONI

EN 1022/05
EN 581-1/06
ENV 581-1/00 e 581-2/00

certificazione IMO

IMBALLO

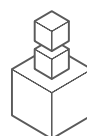

1 pz



18 Kg

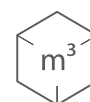

0,162 m³

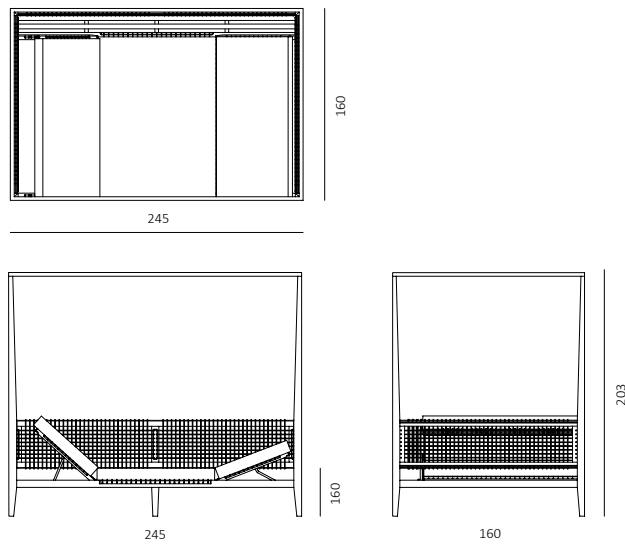

10 x 205 x 79 cm

codice prodotto: **ALSYBI**

Alcova con seduta regolabile su entrambi i lati dalla struttura squadrata in teak con seduta e schienale in waprolace color naturale.

CONDIZIONI DI UTILIZZO

- H** Hard Conditions: locali ad alta frequentazione (bar, pub)
- SG** Seaside
- M** Medium Conditions: utilizzo HORECA

MATERIALI E FINITURE

Telaio in teak

Intreccio WaProLace



Teak



Natural

TIPOLOGIA DI PRODOTTO

Da assemblare

CERTIFICAZIONI

EN 1022/05
EN 581-1/06
ENV 581-1/00 e 581-2/00

certificazione IMO

IMBALLO

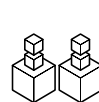

3 pz

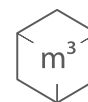
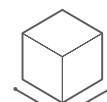

98 Kg

2,028 m³

175 x 265 x 45 cm

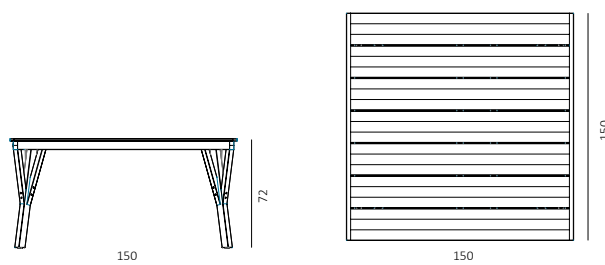
codice prodotto: **TASYQU**

Tavolo quadrato dalla struttura squadrata in teak.

CONDIZIONI DI UTILIZZO**H**

Hard Conditions: locali ad alta frequentazione (bar, pub)

SG

Seaside

M

Medium Conditions: utilizzo HORECA

MATERIALI E FINITURE

Telaio in teak



Teak

TIPOLOGIA DI PRODOTTO

Da assemblare

CERTIFICAZIONI

EN 1022/05
 EN 581-1/06
 ENV 581-1/00 e 581-2/00

certificazione IMO

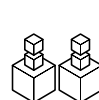
IMBALLO

2 pz

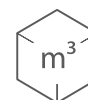

44,8 Kg

0,292 m³

156 x 156 x 12 cm

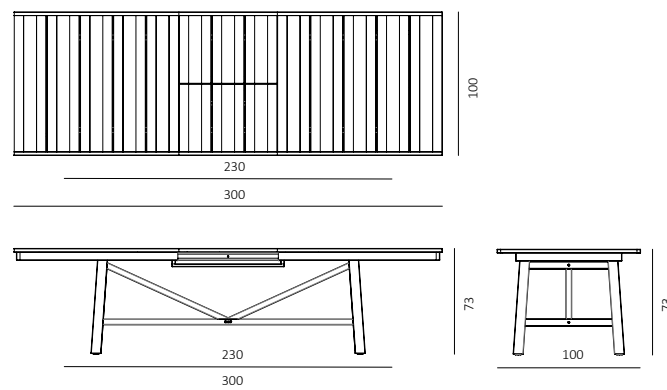
codice prodotto: **TASY**

Tavolo rettangolare allungabile dalla struttura squadrata in teak.

CONDIZIONI DI UTILIZZO

- H** Hard Conditions: locali ad alta frequentazione (bar, pub)
- SG** Seaside
- M** Medium Conditions: utilizzo HORECA

MATERIALI E FINITURE

Telaio in teak



Teak

TIPOLOGIA DI PRODOTTO

Da assemblare

CERTIFICAZIONI

EN 1022/05
EN 581-1/06
ENV 581-1/00 e 581-2/00

certificazione IMO

IMBALLO

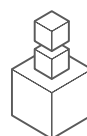

1 pz



106,6 Kg

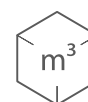

0,891 m³

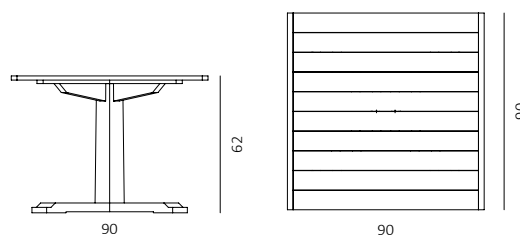

35 x 107 x 238 cm

codice prodotto: **TASYQB**

Tavolo quadrato dalla struttura squadrata in teak.

CONDIZIONI DI UTILIZZO**H**

Hard Conditions: locali ad alta frequentazione (bar, pub)

SG

Seaside

M

Medium Conditions: utilizzo HORECA

MATERIALI E FINITURE

Telaio in teak



Teak

TIPOLOGIA DI PRODOTTO

Da assemblare

CERTIFICAZIONI

EN 1022/05
 EN 581-1/06
 ENV 581-1/00 e 581-2/00

certificazione IMO

IMBALLO

2 pz

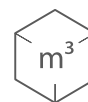

22,8 Kg

0,339 m³

62 x 74 x 74 cm

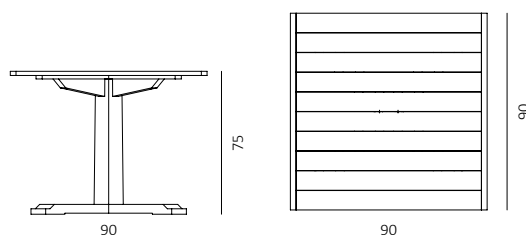
codice prodotto: **TAQULESY**

Tavolo quadrato dalla struttura squadrata in teak.

CONDIZIONI DI UTILIZZO**H**

Hard Conditions: locali ad alta frequentazione (bar, pub)

SG

Seaside

M

Medium Conditions: utilizzo HORECA

MATERIALI E FINITURE

Telaio in teak



Teak

TIPOLOGIA DI PRODOTTO

Da assemblare

CERTIFICAZIONI

EN 1022/05
 EN 581-1/06
 ENV 581-1/00 e 581-2/00

certificazione IMO

IMBALLO

2 pz

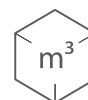

22 Kg

0,094 m³

72 x 74 x 74 cm

codice prodotto: **SYTARO**

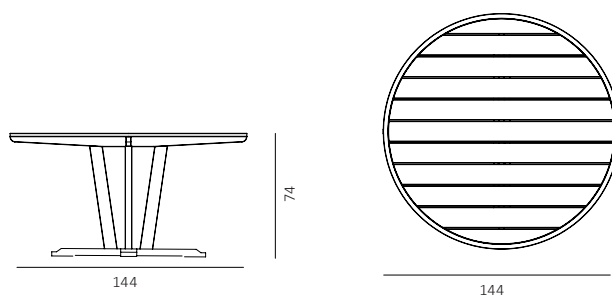

Tavolo rotondo dalla struttura squadrata in teak.

CONDIZIONI DI UTILIZZO



Hard Conditions: locali ad alta frequentazione (bar, pub)



Seaside



Medium Conditions: utilizzo HORECA

MATERIALI E FINITURE

Telaio in teak



Teak

TIPOLOGIA DI PRODOTTO

Da assemblare

CERTIFICAZIONI

IMBALLO



1 pz



35 Kg

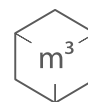

0,45 m³

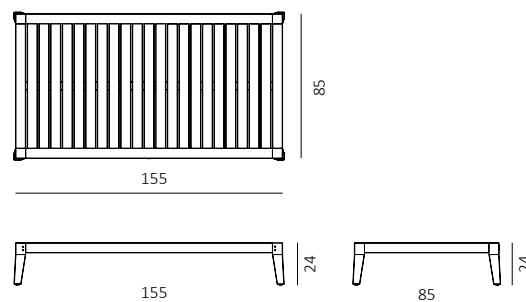

150 x 150x 20

codice prodotto: **SYTABR**

Tavolino rettangolare dalla struttura squadrata in teak.

CONDIZIONI DI UTILIZZO**H**

Hard Conditions: locali ad alta frequentazione (bar, pub)

SG

Seaside

M

Medium Conditions: utilizzo HORECA

MATERIALI E FINITURE

Telaio in teak



Teak

TIPOLOGIA DI PRODOTTO

Da assemblare

CERTIFICAZIONI

EN 1022/05
 EN 581-1/06
 ENV 581-1/00 e 581-2/00

certificazione IMO

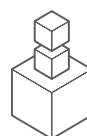
IMBALLO

1 pz

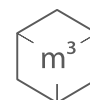

25,98 Kg

0,152 m³

90 x 154 x 11 cm

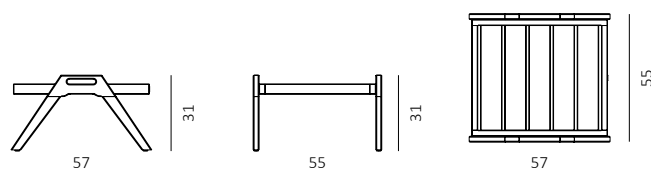
codice prodotto: **SYTABQM**

Tavolo basso quadrato con maniglie dalla struttura squadrata in teak.

Prodotto impilabile.

CONDIZIONI DI UTILIZZO

- H** Hard Conditions: locali ad alta frequentazione (bar, pub)
- SG** Seaside
- M** Medium Conditions: utilizzo HORECA

MATERIALI E FINITURE

Telaio in teak



Teak

TIPOLOGIA DI PRODOTTO

Da assemblare

CERTIFICAZIONI

EN 1022/05
EN 581-1/06
ENV 581-1/00 e 581-2/00

certificazione IMO

IMBALLO

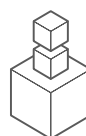

1 pz



5,8 Kg

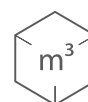

0,034 m³

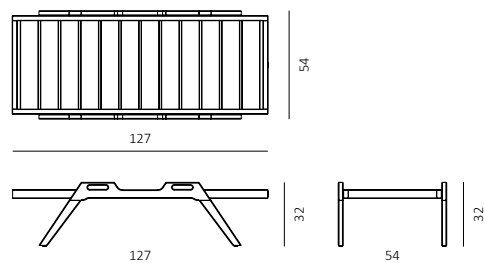

64 x 54 x 10 cm

codice prodotto: **SYTABRM**

Tavolo basso rettangolare con maniglie dalla struttura squadrata in teak.

Prodotto impilabile.

CONDIZIONI DI UTILIZZO

- H** Hard Conditions: locali ad alta frequentazione (bar, pub)
- SG** Seaside
- M** Medium Conditions: utilizzo HORECA

MATERIALI E FINITURE

Telaio in teak



Teak

TIPOLOGIA DI PRODOTTO

Da assemblare

CERTIFICAZIONI

EN 1022/05
EN 581-1/06
ENV 581-1/00 e 581-2/00

certificazione IMO

IMBALLO

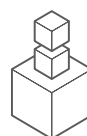

1 pz



11,2 Kg

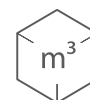

0,069 m³



135 x 9 x 57 cm

CURA E MANUTENZIONE

TEAK

I trattamenti a cui sottoporre il teak annualmente sono di due tipi. Manutenzione Ordinaria (semplice trattamento di pulizia e lucidatura, adatto a mobili non esposti all'esterno o di recente acquisto): lavare il mobile con sapone neutro (sapone di Marsiglia), fare asciugare completamente al sole e applicare qualche goccia di olio di teak, usando un panno di cotone (è sconsigliato l'uso del pennello in quanto creerebbe una patina che impedirebbe al teak di traspirare). Manutenzione straordinaria (trattamento di pulizia più profondo, finalizzato al ripristino della colorazione color miele): questo trattamento è consigliato per mobili esposti all'esterno che hanno già raggiunto la tipica colorazione argentea. Passare carta vetrata molto fine per togliere la patina argentata. Lavare con acqua e sapone neutro (sapone di Marsiglia) e lasciare asciugare al sole. Applicare qualche goccia di olio di teak con un pennello di media grandezza e asciugare completamente al sole. Se una volta asciugato dovesse risultare poroso (caratteristica dei pigmenti che compongono l'olio) si consiglia di passare un panno umido su tutto il mobile. Per i mobili appena acquistati si consiglia di passare un panno leggermente umido prima di posizionare i cuscini per togliere un po' di oleosità e prevenire macchie su indumenti o cuscini.

WAPROLACE

Per mantenere pulita la fibra sintetica WaProLace® Unopiù ha messo a punto un kit di pulizia ad hoc. Il kit è composto da un detergente speciale non schiumogeno che rimuove lo sporco e ripristina l'aspetto della fibra e uno spray di protezione che alimenta i plastificanti e mantiene la flessibilità della fibra. Il filtro UV ne mantiene inoltre l'aspetto e prolunga la durata nel tempo aiutando a prevenire le macchie.

CARE AND MAINTENANCE

TEAK

There are two types of treatments to be applied annually. Ordinary maintenance (standard cleaning and polishing treatment suitable for recently purchased or indoor furniture): clean the furniture with neutral soap (Marseille soap), let it dry completely under the sun, apply few drops of teak oil using a soft cotton cloth (we do not recommend using a brush as it could create a patina that would prevent the teak from breathing). Deep maintenance (deeper cleansing treatment aimed at restoring the original honey color): this treatment is recommended for outdoor furniture which has reached its typical silver colour. Use very fine sandpaper to remove the natural grey patina, rinse with water and neutral soap (Marseille soap) and let fully dry under the sun. Apply few drops of teak oil with a medium-sized brush and let fully dry again under the sun. After the treatment, should the furniture be porous (characteristic of the oil pigments) we recommend wiping the entire furniture with a damp cloth. For newly purchased furniture we recommend wiping with a slightly damp cloth before placing the cushions to remove natural oils and prevent stains on the clothing and cushions.

WAPROLACE

To keep the synthetic fiber clean WaProLace® Unopiù has developed a specific kit. The kit is made of a special non-foaming detergent that removes dirt and restores the fiber and a protective spray that revives the plasticizers and maintains the fiber's flexibility. The UV filter helps the fiber maintain its appearance and extends its duration over time, protecting it from stains.

CURA E MANUTENZIONE

TEAK

I trattamenti a cui sottoporre il teak annualmente sono di due tipi. Manutenzione Ordinaria (semplice trattamento di pulizia e lucidatura, adatto a mobili non esposti all'esterno o di recente acquisto): lavare il mobile con sapone neutro (sapone di Marsiglia), fare asciugare completamente al sole e applicare qualche goccia di olio di teak, usando un panno di cotone (è sconsigliato l'uso del pennello in quanto creerebbe una patina che impedirebbe al teak di traspirare). Manutenzione straordinaria (trattamento di pulizia più profondo, finalizzato al ripristino della colorazione color miele): questo trattamento è consigliato per mobili esposti all'esterno che hanno già raggiunto la tipica colorazione argentea. Passare carta vetrata molto fine per togliere la patina argentata. Lavare con acqua e sapone neutro (sapone di Marsiglia) e lasciare asciugare al sole. Applicare qualche goccia di olio di teak con un pennello di media grandezza e asciugare completamente al sole. Se una volta asciugato dovesse risultare poroso (caratteristica dei pigmenti che compongono l'olio) si consiglia di passare un panno umido su tutto il mobile. Per i mobili appena acquistati si consiglia di passare un panno leggermente umido prima di posizionare i cuscini per togliere un po' di oleosità e prevenire macchie su indumenti o cuscini.

CARE AND MAINTENANCE

TEAK

There are two types of treatments to be applied annually. Ordinary maintenance (standard cleaning and polishing treatment suitable for recently purchased or indoor furniture): clean the furniture with neutral soap (Marseille soap), let it dry completely under the sun, apply few drops of teak oil using a soft cotton cloth (we do not recommend using a brush as it could create a patina that would prevent the teak from breathing). Deep maintenance (deeper cleansing treatment aimed at restoring the original honey color): this treatment is recommended for outdoor furniture which has reached its typical silver colour. Use very fine sandpaper to remove the natural grey patina, rinse with water and neutral soap (Marseille soap) and let fully dry under the sun. Apply few drops of teak oil with a medium-sized brush and let fully dry again under the sun. After the treatment, should the furniture be porous (characteristic of the oil pigments) we recommend wiping the entire furniture with a damp cloth. For newly purchased furniture we recommend wiping with a slightly damp cloth before placing the cushions to remove natural oils and prevent stains on the clothing and cushions.