

codice prodotto: **LUNDIG**

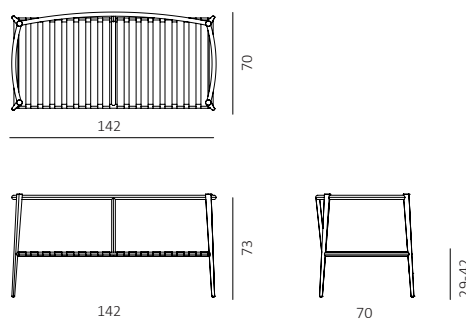

Divanetto 2 posti in alluminio e corda di polipropilene

CONDIZIONI DI UTILIZZO

- H** Hard Conditions: locali ad alta frequentazione (bar, pub)
- SG** Seaside
- M** Medium Conditions: utilizzo HORECA

MATERIALI E FINITURE

Telaio in Alluminio

Rivestimento in Corda



Grafite

Avorio



Antracite

Grigio

TIPOLOGIA DI PRODOTTO

Assemblato

IMBALLO

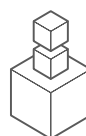

1 pz



17 Kg

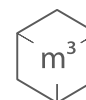

0,729 m³



137 x 71 x 75 cm

codice prodotto: **LUNPOG**

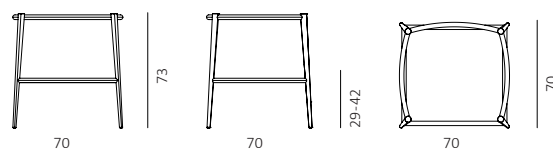

Poltrona in alluminio e corda di polipropilene

CONDIZIONI DI UTILIZZO

- H** Hard Conditions: locali ad alta frequentazione (bar, pub)
- SG** Seaside
- M** Medium Conditions: utilizzo HORECA

MATERIALI E FINITURE

Telaio in Alluminio

Rivestimento in Corda



Grafite

Avorio

Antracite

Grigio

TIPOLOGIA DI PRODOTTO

Assemblato

IMBALLO

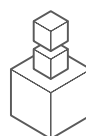

1 pz



12 Kg

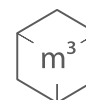

0,394 m³



72 x 73 x 75 cm

codice prodotto: **LUNSBG**

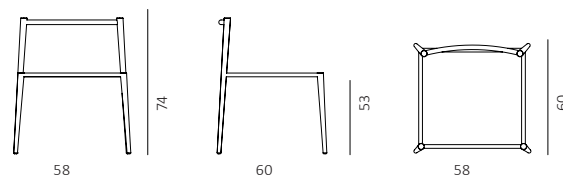

Sedia impilabile in alluminio e corda di polipropilene

CONDIZIONI DI UTILIZZO

- H** Hard Conditions: locali ad alta frequentazione (bar, pub)
- SG** Seaside
- M** Medium Conditions: utilizzo HORECA

MATERIALI E FINITURE

Telaio in Alluminio

Rivestimento in Corda



Grafite

Avorio



Antracite

Grigio

TIPOLOGIA DI PRODOTTO

Assemblato

IMBALLO

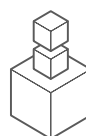

2 pz



14 Kg

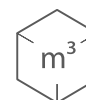

0,327 m³



68 x 61 x 79 cm

codice prodotto: **LUNSEG**

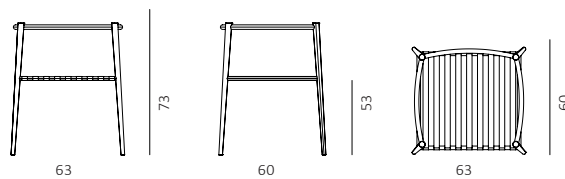

Poltroncina impilabile in alluminio e corda di polipropilene

CONDIZIONI DI UTILIZZO

H

Hard Conditions: locali ad alta frequentazione (bar, pub)

SG

Seaside

M

Medium Conditions: utilizzo HORECA

MATERIALI E FINITURE

Telaio in Alluminio



Grafite

Avorio

Rivestimento in Corda



Antracite

Grigio

TIPOLOGIA DI PRODOTTO

Assemblato

IMBALLO

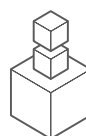

2 pz



15 Kg

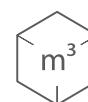

0,336 m³



67 x 67 x 75 cm

codice prodotto: **LUNSGAG**

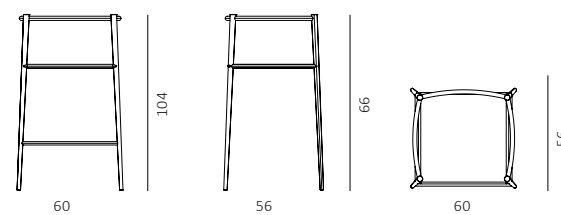

Sgabello alto in alluminio e corda di polipropilene

CONDIZIONI DI UTILIZZO

- H** Hard Conditions: locali ad alta frequentazione (bar, pub)
- SG** Seaside
- M** Medium Conditions: utilizzo HORECA

MATERIALI E FINITURE

Telaio in Alluminio

Rivestimento in Corda



Grafite

Avorio



Antracite

Grigio

TIPOLOGIA DI PRODOTTO

Assemblato

IMBALLO

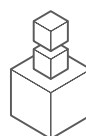

1 pz



12 Kg

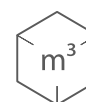

0,380 m³



60 x 61 x 106 cm

codice prodotto: **LUNTABAQUG**

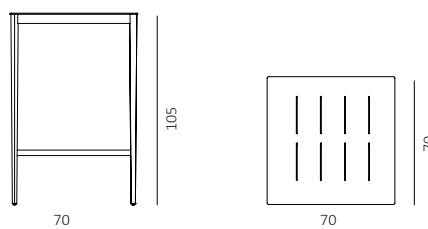

Tavolo alto quadrato in alluminio

CONDIZIONI DI UTILIZZO

- H** Hard Conditions: locali ad alta frequentazione (bar, pub)
- SG** Seaside
- M** Medium Conditions: utilizzo HORECA

MATERIALI E FINITURE

Telaio in Alluminio

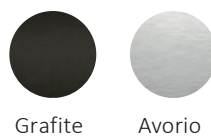

TIPOLOGIA DI PRODOTTO

Da assemblare

IMBALLO

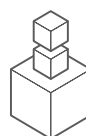

1 pz



18 Kg

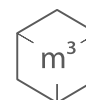

0,180 m³



74 x 114 x 19 cm

codice prodotto: **LUNTABAREG**

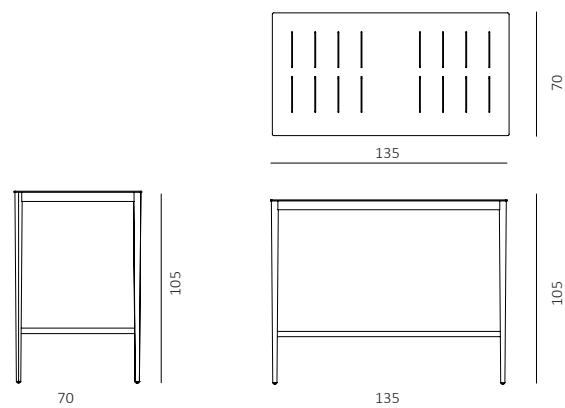

Tavolo alto rettangolare in alluminio

CONDIZIONI DI UTILIZZO

- H** Hard Conditions: locali ad alta frequentazione (bar, pub)
- SG** Seaside
- M** Medium Conditions: utilizzo HORECA

MATERIALI E FINITURE

Telaio in Alluminio

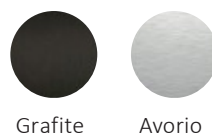

TIPOLOGIA DI PRODOTTO

Da assemblare

IMBALLO

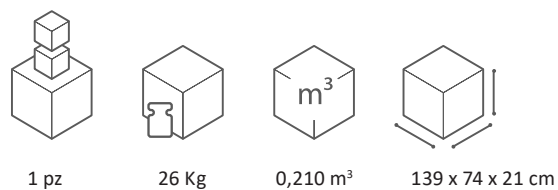

codice prodotto: **LUSDRG - LUSDRB**

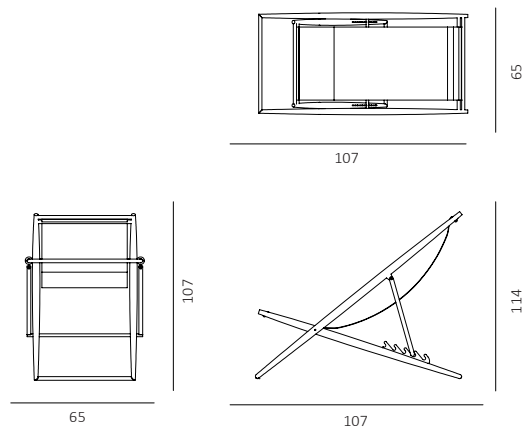

Sdraio in alluminio e telo

CONDIZIONI DI UTILIZZO

- H** Hard Conditions: locali ad alta frequentazione (bar, pub)
- SG** Seaside
- M** Medium Conditions: utilizzo HORECA

MATERIALI E FINITURE

Telaio in Alluminio



Grafite



Avorio



Telo

TIPOLOGIA DI PRODOTTO

Da assemblare

IMBALLO

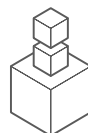

1 pz



26 Kg

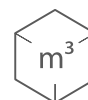

0,210 m³



139 x 74 x 21 cm

CURA E MANUTENZIONE**ALLUMINIO**

Per mantenere pulito l'alluminio è sufficiente una bacinella con acqua pulita tiepida, un detergente solido o liquido neutro – non abrasivo e non a base di ammoniaca, candeggina o alcool – panni morbidi e una spugna non abrasiva. Utilizzare il panno morbido per asciugare ed evitare la formazione di aloni. Si raccomanda di utilizzare solo acqua tiepida a temperatura massima di 30°. Nel caso di macchie persistenti utilizzare una soluzione di aceto, sapone di Marsiglia neutro o bicarbonato (un cucchiaino di sapone/bicarbonato per ogni litro di acqua).

CORDA

La corda non necessita di un trattamento specifico, ma se si desidera si può provvedere a lavarla periodicamente. Per non danneggiarla durante questa operazione si suggerisce di utilizzare solo acqua pulita e tiepida (temperatura non superiore ai 30°C), un detergente neutro come il sapone di Marsiglia o per i tessuti delicati, ed infine una spazzola sintetica a setole morbide. Una volta terminata la fase di lavaggio si consiglia di far asciugare la corda in un luogo all'ombra, lontano da fonti di calore e possibilmente all'aria aperta.

CARE AND MAINTENANCE**ALUMINUM**

To maintain the aluminium clean use a basin with warm clean water, a solid or neutral liquid detergent (non-abrasive and not ammonia, bleach or alcohol-based) soft cloths and a non-abrasive sponge. Use a soft cloth to prevent halos. It is recommended to use only lukewarm water (maximum 30°C). In case of persistent stains use a solution of vinegar, neutral Marseille soap or bicarbonate (a spoonful of soap/bicarbonate for each liter of water).

ROPE

Rope does not need any special maintenance, but it can be washed periodically. To avoid damaging the rope during this operation please use clean, lukewarm water (temperature not exceeding 30°C), a neutral detergent such as Marseille soap or one for delicate fabric, and a synthetic brush with soft bristles. Once the rope is cleaned, let it dry away from direct sunlight, possibly in the shadow, away from heat sources and in the open air.